

SW33B

Cutting Board

Suitable for all sinks
Routed edge to lock into bowl
Sapele Hardwood
Easy clean finish

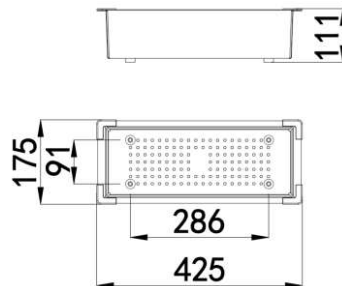

SW32C

Colander

Suitable for all sinks
Drop into sinks
Safety corners
304 grade stainless steel

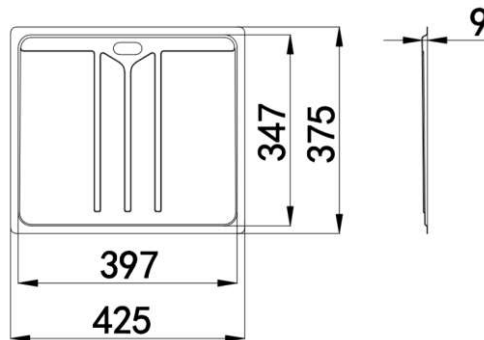

SW76T

Drainer Tray

Suitable for all sinks
304 grade stainless steel
Flush sink fitting

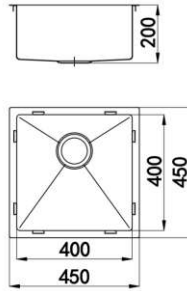

SW45SB

30 Litre capacity
 90mm rear waste (basket waste included)
 304 grade stainless steel 1.2mm thick
 Inset with sink clips or undermount
 Cut out template included
 10mm radius corners for easy cleaning
 Accessories available

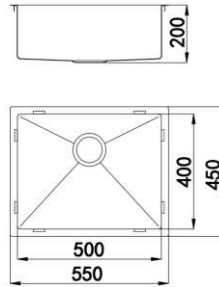

SW55SB

38 Litre capacity
 90mm rear waste (basket waste included)
 304 grade stainless steel 1.2mm thick
 Inset with sink clips or undermount
 Cut out template included
 10mm radius corners for easy cleaning
 Accessories available

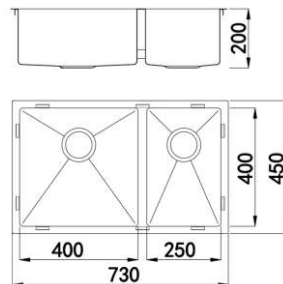

SW73DB-LH

30 x 19 Litre capacity
 90mm rear waste (basket waste included)
 304 grade stainless steel 1.2mm thick
 Inset with sink clips or undermount
 Cut out template included
 10mm radius corners for easy cleaning
 Accessories available
SW73DB-LH (Left hand main bowl)

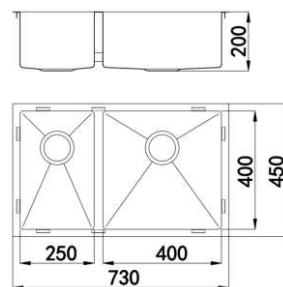

SW73DB-RH

30 x 19 Litre capacity
 90mm rear waste (basket waste included)
 304 grade stainless steel 1.2mm thick
 Inset with sink clips or undermount
 Cut out template included
 10mm radius corners for easy cleaning
 Accessories available
SW73DB-RH (Right hand main bowl)

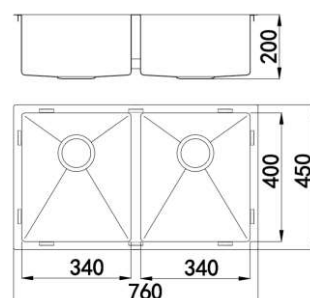

SW76DB

26 x 26 Litre capacity
 90mm rear waste (basket waste included)
 304 grade stainless steel 1.2mm thick
 Inset with sink clips or undermount
 Cut out template included
 10mm radius corners for easy cleaning
 Accessories available