



Industry leading stainless steel

Wholesale Catalogue Issue 3
2024

MAS[®]





MAS Wholesale stainless steel plumbing supplies for the commercial, residential and construction industry.

EST. 2003

Mark Anderson Sales Pty Ltd is one of Australia's national leaders in the manufacture and supply of commercial and domestic stainless steel plumbing and hardware products.

We supply high quality products to the wholesale and manufacturing industry to meet all your kitchen, bathroom, toilet and associated supply needs. Our extensive network of agents can be found around Australia and seek to ensure that your needs are met promptly and without delay.

Contents

3-4	Wall Mounted Hand Basins	14	Complete Urinals Setup order codes
5	Inset Hand Basins	15	Sparge Spreader Systems
6	Pressed Bowls	16	Urinals & Cistern Spare Parts
7	Swordfish Series	17	Waste Solutions
8	Drop in Laundry Tubs/ Whitsunday Series	18	Trade Waste
9	Laboratory Sinks/ Laboratory Sink Waste Options	19	Tapware
10	Knee Operated Basins/ Stainless Steel Wash Troughs/ Jesse Series/ Benny Bath	20	Ice Wells & Accessories
11	Tundish	21	Hand Fabricated Sink Bowls
12	Stainless Steel Cisterns	22	Glass and Dishwasher Racks/ Feet and Inserts/ Wedge Wire
13	Urinals	23	Stainless Steel Drawers/ Drawers Stacks

Wall Mounted Hand Basins

HB3



400 × 220 × 95mm deep
3.5 Litres
Brackets included
40mm waste outlet
Tap holes available LH or RH

HB1-2



Basin and Brackets
500 × 420 × 180mm deep
13 Litres
40mm waste outlet
HB1 Basin only
HB2 Brackets
Tap holes available LH, RH or Centre

HB300



500 × 420 × 180mm deep
300mm high fixed splashback
13 Litres
HB2 Brackets included
40mm waste outlet
Tap holes available LH, RH or Centre

CS4



CS4 Jumbo hand basin
CS2 Brackets sold separately
555 × 455 × 220mm deep
32 Litres
90mm waste outlet
Tap holes available LH or RH

OFK2



Overflow Kit
Can be fitted to most bowls
New or existing
32mm dia. cut out
500mm of tubing



HB5



360 × 360 × 123mm deep
6.2 Litres
Brackets included
40mm P&W included
Tap holes available LH or RH

HB4



360 × 360 × 123mm deep
6.2 Litres
Brackets included
40mm P&W included
Tap holes available LH, RH or Centre

CS1-2 Cleaners sink with brackets

555 × 455 × 220mm deep
90mm waste outlet
32 Litres
CS1 Cleaners sink
CS2 Brackets only



CS1-3 Cleaners sink with legs

555 × 455 × 220mm deep
90mm waste outlet
32 Litres
CS1 Cleaners sink
CS3 Legs only

Cleaners Sink Splashbacks

Cleaners Sink Optional Splashback
Separate piece 304 grade Stainless steel
SBACK-300 – 300mm HIGH
SBACK-450 – 450mm HIGH
SBACK-600 – 600mm HIGH



Inset Hand Basins

HB6



380 × 380 × 150mm deep
 90mm waste outlet
 9.5 Litres
 Tap holes available LH, RH or Centre

HB7



505 × 415 × 180mm deep
 40mm waste outlet
 13 Litres
 Tap holes available LH, RH or Centre



SB1

SB1

375mm inside dia.
 25mm Flange
 180mm deep
 90mm waste outlet
 17 Litres



RB1

RB1

310mm inside dia
 20mm Flange
 120mm deep
 304 Grade S/S
 P&W included
 7 Litres



RB2

RB2

355mm inside dia
 20mm Flange
 145mm deep
 304 Grade S/S
 P&W included
 12 Litres

RB2316

355mm inside dia
 20mm Flange
 145mm deep
 316 Grade S/S
 P&W included
 12 Litres

Pressed Bowls



PB7



PB1



PB2
PB2316



PB3
PB3316

304 Grade Stainless

Code	Bowl	Flange	Capacity
PB7	285×145×105	15mm	4 Litres
PB1	285×230×150	15mm	9 Litres
PB2	305×305×170	15mm	14 Litres
PB3	355×305×170	15mm	17 Litres
PB4	410×355×170	15mm	22 Litres
PB5	450×400×190	25mm	33 Litres
PB6	510×355×180	15mm	28 Litres
PB8	450×450×250	25mm	40 Litres

* Basket waste not included



PB4
PB4316



PB5



PB6
PB6316



PB8

316 Grade Stainless

Code	Bowl	Flange	Capacity
PB2316	305×305×170	15mm	14 Litres
PB3316	355×305×170	15mm	17 Litres
PB4316	410×355×170	15mm	22 Litres
PB4316SB	410×355×80	15mm	10 Litres
PB6316	510×355×180	15mm	28 Litres
PB4316DB	740×410×170	15mm	44 Litres

* Basket waste not included



PB4316DB

Accessories to suit

PB4
PB4316
PB4316SB
PB4316DB



PB4DT



PB4FB

SW45SB

30 Ltr Capacity
 90mm rear waste outlet (Basket waste included)
 304 Grade Stainless Steel @ 1.2mm thick
 Mounting clips for top mount & under mount
 10mm radius corners for easy cleaning

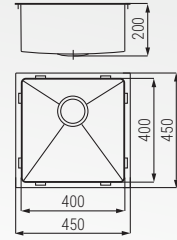

SW55SB

38 Ltr Capacity
 90mm rear waste outlet (Basket waste included)
 304 Grade Stainless Steel @ 1.2mm thick
 Mounting clips for top mount & under mount
 10mm radius corners for easy cleaning

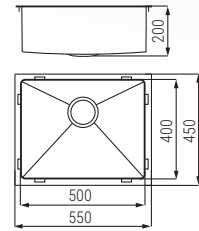

SW73DB-LH

30 × 19 Ltr Capacity
 90mm rear waste outlet (Basket waste included)
 304 Grade Stainless Steel @ 1.2mm thick
 Mounting clips for top mount & under mount
 10mm radius corners for easy cleaning

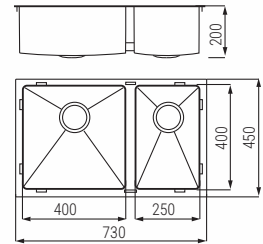

SW73DB-RH

19 × 30 Ltr Capacity
 90mm rear waste outlet (Basket waste included)
 304 Grade Stainless Steel @ 1.2mm thick
 Mounting clips for top mount & under mount
 10mm radius corners for easy cleaning

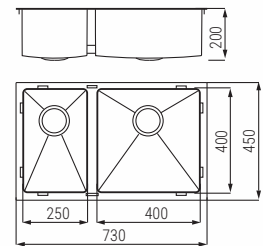

SW76DB

26 × 26 Ltr Capacity
 90mm rear waste outlet / Basket waste included
 304 Grade Stainless Steel @ 1.2mm thick
 Mounting clips for top mount & under mount
 10mm radius corners for easy cleaning

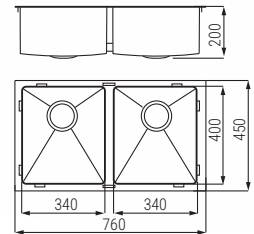

SW76T

Draining Tray

Suitable for all sinks
 304 Grade Stainless Steel
 Flush sink fitting or side use



SW32C

Colander

Suitable for all sinks
 Drops into sink
 Safety Corners and feet
 304 Grade Stainless Steel



SW33B

Cutting Board

Suitable for all sinks
 Locks into sink edge
 Quality hardwood design



Drop in Laundry tubs

HF3WF

37.5 Ltr capacity
 304 Grade Stainless Steel @ 1.2mm thick
 Bowl size: 400 × 350 × 300mm Flange: 25mm
 25mm radius corners for easy cleaning
Accessories available: SW32C, SW33B and SW76T

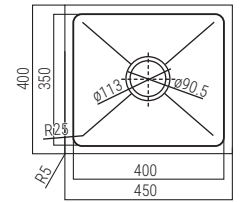

HF12WF

50 Ltr capacity
 304 Grade Stainless Steel @ 1.2mm thick
 Bowl size: 450 × 400 × 300mm Flange: 25mm
 25mm radius corners for easy cleaning
Accessories available: SW32C, SW33B and SW76T

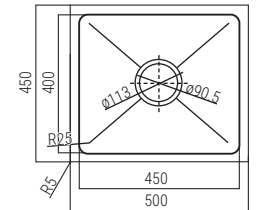

HF6WF

55.5 Ltr capacity
 304 Grade Stainless Steel @ 1.2mm thick
 Bowl size: 450 × 450 × 300mm Flange: 25mm
 25mm radius corners for easy cleaning

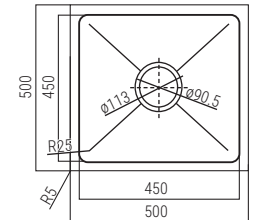

HF18WF

55 Ltr capacity
 304 Grade Stainless Steel @ 1.2mm thick
 Bowl size: 600 × 450 × 217mm Flange: 25mm
 25mm radius corners for easy cleaning
Accessories available: HF3B3 Heavy duty cutting board

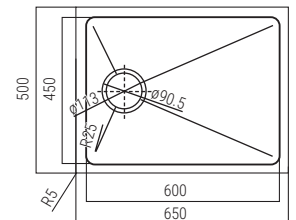

Whitsunday Series

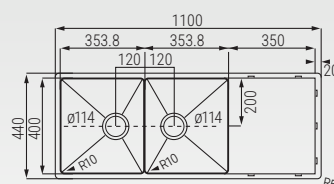

WH1100

30 × 30 Ltr capacity
 304 Grade Stainless Steel @ 1.0mm thick
 90mm offset centred waste Fully reversible design
 Bowl size: 2 @ 400 × 353 × 220mm
 10mm radius corners for easy cleaning
 Basket waste included
Accessories available: SW32C and SW33B

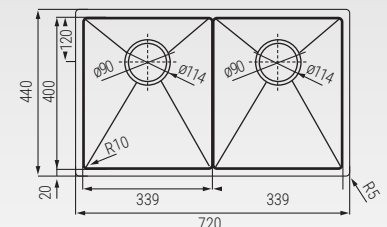

WH720

26 × 26 Ltr capacity
 304 Grade Stainless Steel @ 1.0mm thick
 Bowl size: 2 @ 400 × 340 × 200 mm
 10mm radius corners for easy cleaning
 90mm rear waste outlet
 Basket waste included
Accessories available: SW32C and SW33B

Laboratory Sinks

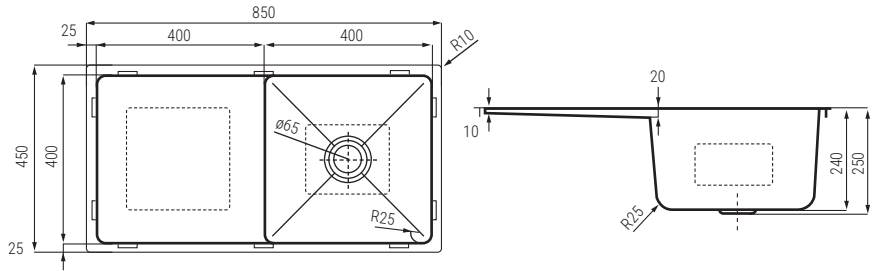

LAB44WD

Laboratory Sinks 316 Grade Stainless Steel

Code	Bowl	Flange	Capacity
LAB99	305×305×150	45 mm	13 Ltr
LAB3325	300×300×250	45mm	19.5 Ltr
LAB4325	400×300×250	45mm	26 Ltr
LAB4430	400×400×300	45mm	43 Ltr
LAB44WD	400×400×250	25mm	36 Ltr



LAB99

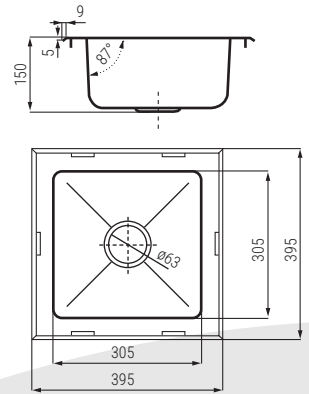

LAB3325

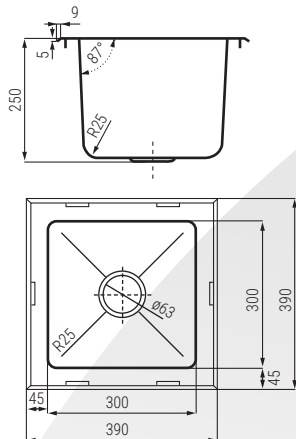

LAB4325

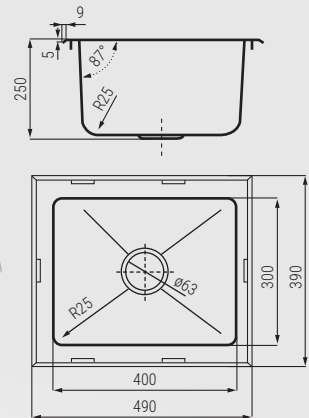

LAB4430

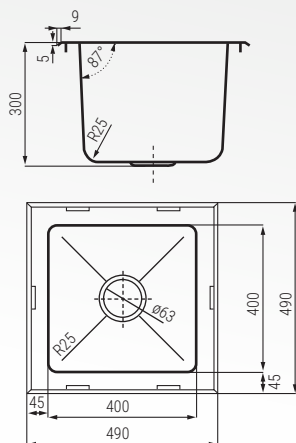

Laboratory Sink Waste Options



PW50AR

50mm Poly plug & waste acid resistant



PW50ARS

50mm Stainless steel plug & waste acid resistant

Knee Operated Basins



Optional
300mm
splashback available

CODE: SBACK

KO1

Time flow valve-one press for activation
15 seconds (+5/-5) to suit AS 4674-2004 clause 4.42
With temperature mixing valve

KO1XX

Time flow valve-one press for activation
15 seconds (+5/-5) to suit AS 4674-2004 clause 4.42
Without temperature mixing valve

KO2

NON time flow valve
Hold panel for activation
With temperature mixing valve

KO2XX

NON time flow valve
Hold panel for activation
Without temperature mixing valve

Stainless Steel Wash Troughs

- WT12** 1200mm long wall hung wash trough
- WT15** 1500mm long wall hung wash trough
- WT18** 1800mm long wall hung wash trough



Jesse Series



JES44

Linen pattern stainless steel single bowl
Reduced scratch surface
400 × 400 × 200mm 25mm Flange
304 Grade Stainless Steel @ 1.2mm thick
30 Ltr Capacity
90mm rear waste outlet
Basket waste included

Benny Bath



BB01

Linen pattern stainless steel Baby Bath
Reduced scratch surface
597 × 455 × 200mm 30mm Flange
304 Grade Stainless Steel @ 1.2mm thick
50mm waste outlet
Plug & waste included

TD3

Tundish with stainless windowed face plate
 50mm air break
 Stainless steel body and screws
 Self-draining body design
 Inlets 25×35×25mm
 Outlet 40mm bsp
 Maximum wall thickness 13mm
 Design registered
 Other face plate options available

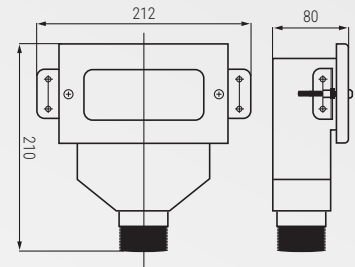

Other face plate options available

TD3XL

Tundish with stainless windowed face plate
 Extended front tapered design for double thick or tiled walling
 50mm air break
 Stainless steel body and screws
 Self-draining body design
 Inlets 25×35×25mm
 Outlet 40mm bsp
 Maximum wall thickness 37mm
 Design registered
 Other face plate options available

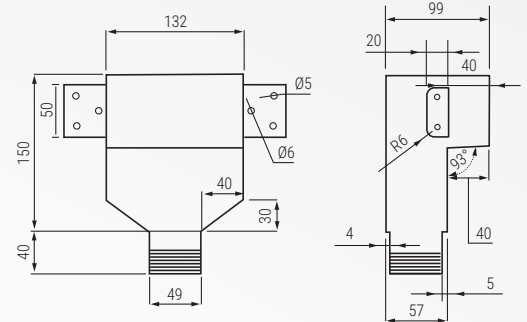

TD6

Countertop Tundish
 48mm conical inlet
 c/p brass body
 Self-draining design
 Outlet 20mm bsp
 Counter top lock nut

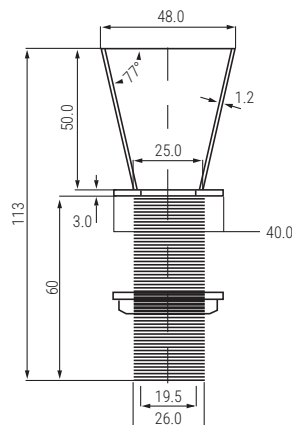

TD9

On Wall Tundish
 100 × 85mm inlet
 Stainless steel body
 Self-draining design
 Outlet 40mm bsp

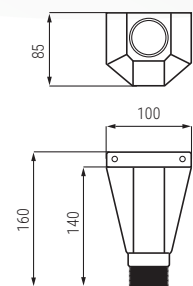

Stainless Steel Cisterns

CN1



Top press single flush
2.6L flush
Inlet LH 15mm bsp – reversible
outlet – 50mm bsp
CN1 Spare parts available
Inlet valve CNZ1
Outlet valve CNZ3

CN2



Front press dual flush
3L half/6L full flush
Inlet LH 15mm bsp – reversible
outlet – 50mm bsp
CN2 Spare parts available
Inlet valve CNZ1
Outlet valve CNZ4

CN3



Top press dual flush
3L half/6L full flush
Inlet LH 15mm bsp – reversible
outlet – 50mm bsp
CN3 Spare parts available
Inlet valve CNZ1
Outlet valve CNZ5
Dual flush button only CNZ5A

CN4



Pull Chain single flush
2.6L flush
Inlet LH 15mm bsp – reversible
outlet – 40mm bsp
CN4 Spare parts available
Inlet valve CNZ1
Outlet valve CNZ6

CN5

Care button dual flush
3L half/ 6 L full flush
Inlet LH 15mm bsp – reversible
outlet – 50mm bsp
CN5 Spare parts available
Inlet valve CNZ1
Outlet valve CNZ5
Dual flush button only CNZ5B

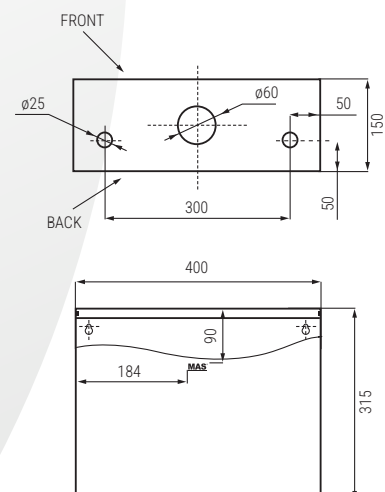

CN - Blank cistern case with set holes

CN11 - Blank cistern case NO holes



UR1

330mm Single Stall Urinal
 Inlet – 20 or 25mm sparge pipe (not included)
 Outlet – SP4 domed urinal grate included



UR4

600mm urinal
 Inlet – SP5A sparge pipe included 40×750mm
 LH Outlet – SP4 domed urinal grate included

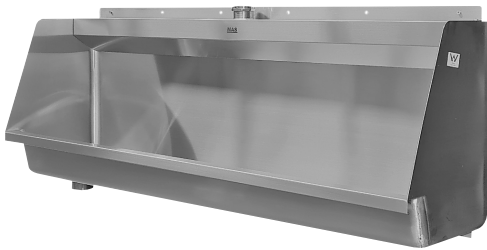

UR2

1200mm urinal
 Inlet – SP5A sparge pipe included 40×750mm
 LH Outlet – SP4 domed urinal grate included

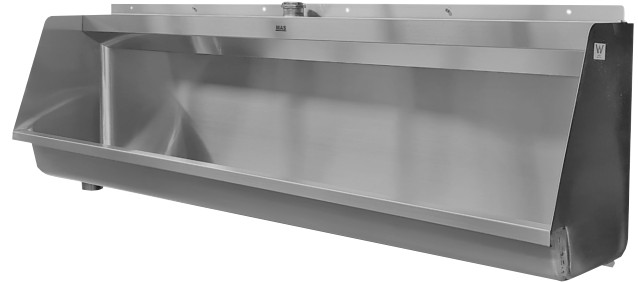

UR5

1500mm urinal
 Inlet – SP5A sparge pipe included 40×750mm
 LH Outlet – SP4 domed urinal grate included



UR3

1800mm urinal
 Inlet – SP5A sparge pipe included 40×750mm
 LH Outlet – SP4 domed urinal grate included



UR6

2400mm urinal
 Inlets – 2x SP5A sparge pipes included 40×750mm
 LH Outlet – SP4 domed urinal grate included

Complete Urinals Setup order codes

- Urinal trough to suit the sizing you require
- CN4 Pull – chain cistern or cisterns
- SP4 domed urinal grate with 50mm BSP thread
- Flush pipe
- Urinal to flush pipe nut
- Flush pipe to cistern adaptor
- Flush pipe safety clip or clips
- Waterfall spreader

UR1COM

Single stall complete

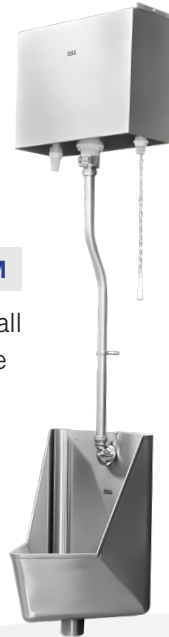

UR4COM

600mm complete



UR2COM

1200mm complete



UR5COM

1500mm complete



UR3COM

1800mm complete



UR6COM

2400mm complete

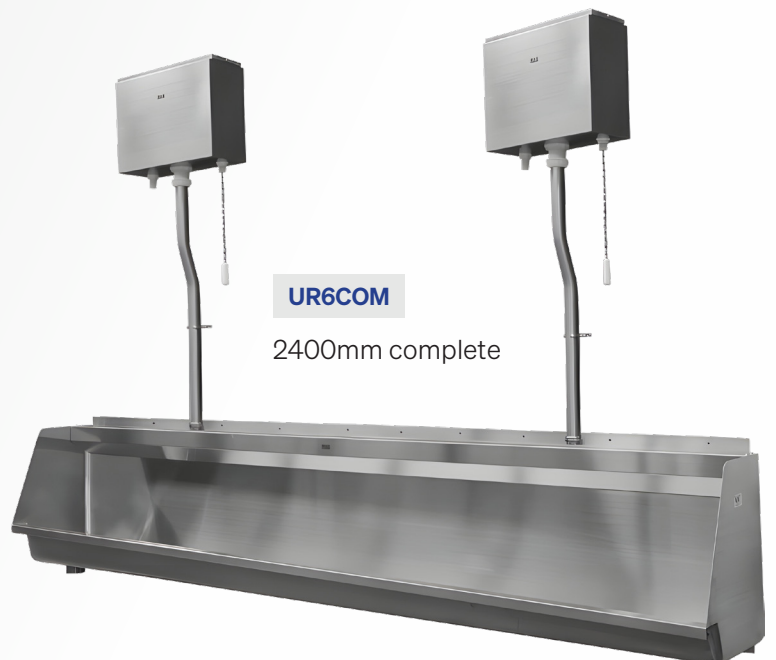

2 TIER

- SP1 Spreader – 2 required
- SPELB elbow – 2 required
- SPTEE 20×20×20 – 1 required
- SP2S straight 1000×20mm pipe – 2 required
- SP2A large offset 1000×20mm pipe – 1 required
- AD3 adaptor 40×20 – 1 required
- CN4 pullchain cistern – 1 required
- 3 x CL20 safety Pipe clips recommended



3 TIER

- SP1 Spreader – 3 required
- SPELB elbow – 2 required
- SPCROSS cross – 1 required
- SP2S straight 1000×20mm pipe – 3 required
- SP2A large offset 1000×20mm pipe – 1 required
- AD3 adaptor 40×20 – 1 required
- CN4 pullchain cistern – 1 required
- 3 x CL20 safety Pipe clips recommended

4 TIER

- SP1 Spreader – 4 required
- SPELB elbow – 2 required
- SPTEE 20×20×20 – 2 required
- SPTEE 20×25×20 – 1 required
- SP2S straight 1000×20mm pipe – 3 required
- SP3A large offset 1000×25mm – 1 required
- AD4 adaptor 40×25 – 1 required
- CN4 pullchain cistern – 1 required
- 4 x CL20 and 1 x CL25 Pipe clip recommended



Urinals & Cistern Spare Parts

Urinal Grates

SP4 Domed Urinal Grate 50mm BSP outlet

SP44 110mm push in urinal grate

SP44A 135mm push in urinal grate

SP4

SP44

Urinal Spreaders

BS1 Button Spreader 15mm bsp rear entry

BS2 Button Spreader 20mm bsp rear entry

SP1 Top entry urinal spreader universal 20 & 25mm

BS1

BS2

SP1

Sparge Pipes

SP2 20mm x 1000mm * 20mm offset

SP2A 20mm x 1000mm * 50mm offset

SP2S 20mm x 1000mm * no offset

SP3 25mm x 1000mm * 20mm offset

SP3A 25mm x 1000mm * 50mm offset

SP5 40mm x 750mm * 20mm offset

SP5A 40mm x 750mm * 40mm offset

Pipe Clips

CL15 15mm

CL20 20mm

CL25 25mm

CL32 32mm

CL40 40mm

CL50 50mm

Sparge Adaptors

AD1 32mm female bsp x 20mm pipe size

AD2 32mm female bsp x 25mm pipe size

AD3 40mm female bsp x 20mm pipe size

AD4 40mm female bsp x 25mm pipe size

AD10 40mm female bsp x 32mm pipe size

AD5 50mm female bsp x 20mm pipe size

AD6 50mm female bsp x 25mm pipe size

AD11 50mm female bsp x 32mm pipe size

AD12 50mm female bsp x 40mm pipe size

Sparge Nuts

AD7 25mm female bsp x 20mm pipe size

AD8 25mm female bsp x 25mm pipe size

AD9 32mm female bsp x 32mm pipe size

AD9A 40mm female bsp x 40mm pipe size





SSBW3

SSBW

SSBW-1



PW9050

PW40

PW50

Scrap Catch

SSBW3 90mm Scrap Catch 3mm primary and secondary strainer holes

SSBW 90mm Scrap Catch

SSBW-1 125mm Scrap Catch for commercial applications

Plug & Waste

PW40 40mm plug & waste

PW50 50mm plug & waste

PW9050 90x50mm plug & waste



BW50

BW90S

BW90L



PW50AR

PW50ARS

Basket Waste

BW50 50x50mm Basket Waste – height 63mm

BW90S 90x50mm Basket waste – height 60mm

BW90L 90x50mm Basket waste – height 80mm

Acid Resistant Wastes

PW50AR 50mm Polypropylene plug & waste acid resistant

PW50ARS 50mm Stainless steel 316 grade plug & waste acid resistant



SSBW20



SSBW40



SSBW60



SSBW80

Commercial Waste

- SSBW20** Standard 90mm outlet, basket & plug
- SSBW60** Standard 125mm outlet, basket & plug
- SSBW40** Standard 90mm outlet – Butterfly valve
- SSBW80** Standard 125mm outlet – Butterfly valve

Basket Only

- SSBW90B**
- SSBW125B**
- SSBW90BB**
- SSBW125BB**



FG300S



FG100R



FG100VB



FG100S



FG200S

Floor / Trough Drains

- FG100S** 150mm square – 100mm pvc
- FG200S** 150mm square – 100mm pvc
- FG300S** 123mm dia weld in – 100mm pvc
- FG400S** 183mm dia weld in – 150mm pvc
- FG100R** 150mm round w/basket – 100mm pvc
- FG100VB** Vinyl with basket – 100mm pvc

Basket Only

- FG100VBR**
- FG100B**
- FG100B**
- FG150B**
- FG100VBR**
- FG100VBR**



MIX20

Basin Mixer



MIX20-DC

Lever handle basin mixer



MIX20SS

Stainless steel basin mixer



MIX22

Sink Mixer



MIX22-DC

Lever handle sink mixer



MIX22SS

Stainless steel sink mixer



PR300

Commercial hob mounted Pre Rinse with pot filler and single lever hot/cold mixer.

Bench Top DriSeals

Taphole seal for laminate bench tops

DS5R DriSeal Round

DS5S DriSeal Square

38mm Taphole

44mm Bench Top Cutout



DS5R



DS5S

Drop In Ice Wells

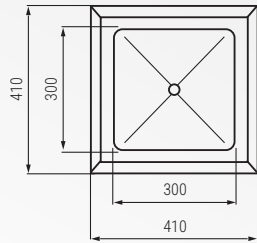

HFW30WF

300×300×200mm Flange 55mm 17 Litres
25mm polyurethane Insulation

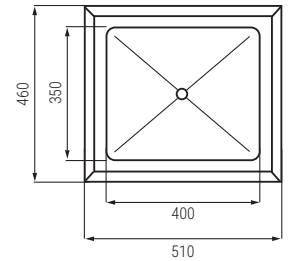

HFW40WF

400×350×300mm Flange 55mm 38 Litres
25mm polyurethane Insulation

Weld In Ice Wells

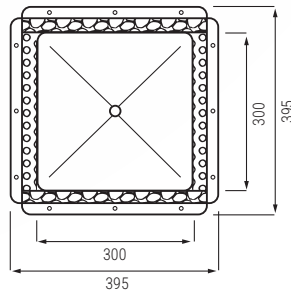

HFW30

300×300×200mm 17 Litres
25mm polyurethane Insulation

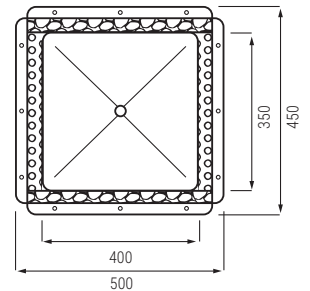

HFW40

400×350×300mm 38 Litres
25mm polyurethane Insulation

Accessories

HFW30-B Lift out basket to suit HFW30 & HFW30WF

HFW40-B Lift out basket to suit HFW40 & HFW40WF

HFW30-L Lid to suit HFW30 & HFW30WF

HFW40-L Lid to suit HFW40 & HFW40WF



Hand Fabricated Sink Bowls

1.2mm 304 grade

Code	W (mm)	D (mm)	H(mm)	Capacity (L)
HF3S	400	350	250	32 L
HF11S	400	400	250	36.5 L
HF12S	450	400	250	41.5 L
HF6S	450	450	250	46.5 L

1.2mm 304 grade stainless steel

Code	W (mm)	D (mm)	H(mm)	Capacity (L)
HF10	300	250	200	13.5 L
HF1	300	300	200	16.5 L
HF2	350	300	300	27.5 L
HF16	355	305	170	16 L
HF21	400	300	300	32 L
HF3	400	350	300	37.5 L
HF17	410	355	170	23 L
HF4	450	300	300	36 L
HF5	450	350	300	43 L
HF52	450	350	200	31.5 L
HF11	400	400	300	43.5 L
HF12	450	400	300	50 L
HF6	450	450	300	55.5 L
HF504	500	400	300	56 L
HF15	500	500	400	94 L
HF7	530	380	300	56 L
HF13	550	450	300	68.5 L
HF9	550	550	300	85 L
HF8	600	450	300	76 L
HF18	600	450	217	55 L
HF14	800	500	300	113 L

1.5mm 316 grade stainless steel

Code	W (mm)	D (mm)	H(mm)	Capacity (L)
HF116	400	400	300	43.5 L
HF66	450	450	300	55.5 L
HF86	600	450	300	76 L

2.0mm 304 grade stainless steel

Code	W (mm)	D (mm)	H(mm)	Capacity (L)
HF112	400	400	300	43.5 L
HF62	450	450	300	55.5 L
HF82	600	450	300	76 L



Waste Options



BW90S, BW90L



PW9050



SSBW



SSBW3



SSBW20



SSBW40

Cutting Boards Available



HFCEB2 to suit HF17, HF5 and HF52

HFCEB3 to suit HF8, HF18, HF18WF, HF82 and HF86

Glass Rack

- GRACK** Glass Rack & Bench Support
- GRADD** Glass rack add on bay
- GRTRA** Glass rack drip tray

Dishwasher Rack

- GRACK-DW** Dishwasher Rack & Bench Support
- GRADD-DW** Dishwasher rack add on bay
- GRTRA-DW** Dishwasher rack drip tray

Additional Extras

- GRSLI** Glass rack tray slides standard pair
- GRSLI-DW** Dishwasher rack tray slides standard pair
- GRSMT** Glass/Dish rack tray slides 1000mm long pair
- GRNOT** Glass/Dish rack notched channel 1000mm long single
- GRNOT15** Glass/Dish rack notched channel 1500mm long single



Feet and Inserts

Inserts

- FEE1625** 25mm SHS insert
- FEE1632** 32mm SHS insert

Adjustable Feet

- FEE1650** 50mm dia. disc foot x 100mm
- FEE1670** 68mm dia. disc foot x 100mm
- FEE16PIN** Floor insert Pin foot x 100mm



Wedge Wire

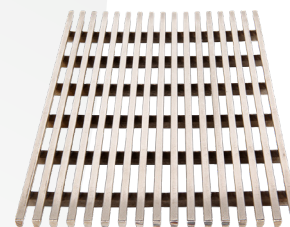

Code	Profile	H (mm)	Grade Stainless
WWS100	3mm wire 5mm gap	9mm	304 grade
WWS100-316	3mm wire 5mm gap	9mm	316 grade
WWS200	3mm wire 3mm gap	10mm	304 grade
WWS200-316	3mm wire 3mm gap	10mm	316 grade
WWS200D	5.3mm wire 3mm gap	10mm	316 grade Reduced slip P5+R13
WWS300	5mm wire 3mm gap	16mm	304 grade Heavy duty

Stainless Steel Drawers

- DR20** Single drawer Lockable
- DR20-KA** Single drawer Keyed Alike
- DR20-NL** Single drawer Non lockable



DR20



DR20-KA



DR20-NL

Drawers Stacks

- DR202LO** 2 Drawer Stack – Lockable
- DR202NL** 2 Drawer Stack – Non lockable
- DR203LO** 3 Drawer Stack – Lockable
- DR203NL** 3 Drawer Stack – Non lockable



- DM100** Self-adhesive sound deadener
Roll size 2500mm x 500mm x 1.6mm thick

- HAN304** Stainless steel handle
146 x 14.2 x 30mm
128mm centre holes

DM100

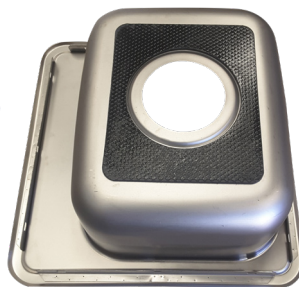

HAN304

Tungsten Electrodes

- WR16ELE** 1.6mm x 175mm (10 Pack)
- WR24ELE** 2.4mm x 175mm (10 Pack)



Weld Wire 316 grade S/S

- WR10316** 1.0mm x 1000mm 5kg box
- WR16316** 1.6mm x 1000mm 5kg box





MARK ANDERSON SALES

ABN 87105051821

MAS Head Office Queensland

Mark Anderson Sales Pty Ltd
Unit 4 / 84 Ingleston Road
Wakerley QLD 4154

Phone: **07 3890 8011**

Email: sales@masales.com.au

North Queensland

Youngs Distribution Centre
8 Whitehouse Street
Garbutt QLD 4814

Phone: 07 4779 0222
nq@masales.com.au

New South Wales

Grates2Go P/L
Unit B / 60 Bells Line of Road
North Richmond NSW 2754

Phone: 02 4571 1530
admin@grates2go.com.au

Victoria

Hotwire Agencies
Unit 1 / 7-9 Newcastle Road
Bayswater VIC 3153

Phone: 1300 HOTWIRE
info@hotwireheating.com.au

Tasmania

R M Daniels & Co
2 / 10 Kennedy Drive
Cambridge TAS 7170

Phone: 03 6248 4872
sales@rmdaniels.com.au

South Australia & NT

Harsmith Building Products
12A Circuit Drive
Hendon SA 5014

Phone: 0408 516 682
admin@harsmithbp.com

West Australia

Pride Industries
138 Hasler Road
Osborne Park WA 6017

Phone: 08 9272 6511
sales@prideindustries.com.au

Residential

Commercial

Hospitality

Construction

